

**双龙集团有限公司**

上海 | 总部  
地址: 上海市嘉定区南翔工业开发区德力西路299号  
电话: 400 622 6268

**SHUANGLONG GROUP CO., LTD.**

Shanghai (Headquarters)  
Address: No. 299, Delixi Rd, Jiading District, Shanghai  
Tel: 400 622 6268

Further products-更多产品, 详见官网www.shuanglong.com



\* 因发展需要, 本公司保留设备规格、外形、配置变更的权利 (资料如有不符, 以实物为准)。  
\* 本资料中图片和数据归我公司所有, 未经许可, 任何公司和个人不得使用, 否则, 追究其法律责任。



双龙集团官方微信



双龙集团官方网站

**DSH系列 锥形混合机**  
**Conical Screw Mixer Series**



**卓越品质 EXCELLENT QUALITY**

锥形混合机的搅拌部件为一条长螺旋或两条不对称螺旋; 它们在绕自己的轴线转动(自转)的同时, 还借助悬臂的转动环绕锥形容器的中心轴沿锥形容器的内壁做行星运动(公转); 该设备通过螺旋的公、自转使物料反复提升, 在锥体内产生剪切、对流、扩散等复合运动, 从而达到混合均匀的目的。本机的优点是适用范围广、容积大、出料无残留、节能。锥形混合机适用于粉料与粉料、粉料与少量液体的混合, 还可以根据用户的要求制作加热、冷却、正压、真空等各种特殊形式。

The conical screw mixer consists of one long screw and one short screw. The long screw lift the material up and fall down with gravity. At the same time, the screw arms run slowly by means of revolution. This type of mixer is widely used for powder mixing and powder mixing with little liquid, without residues and low energy consumption. It could be tailor designed for heating, cooling, positive pressure and vacuum function.

**可选项 | Options**

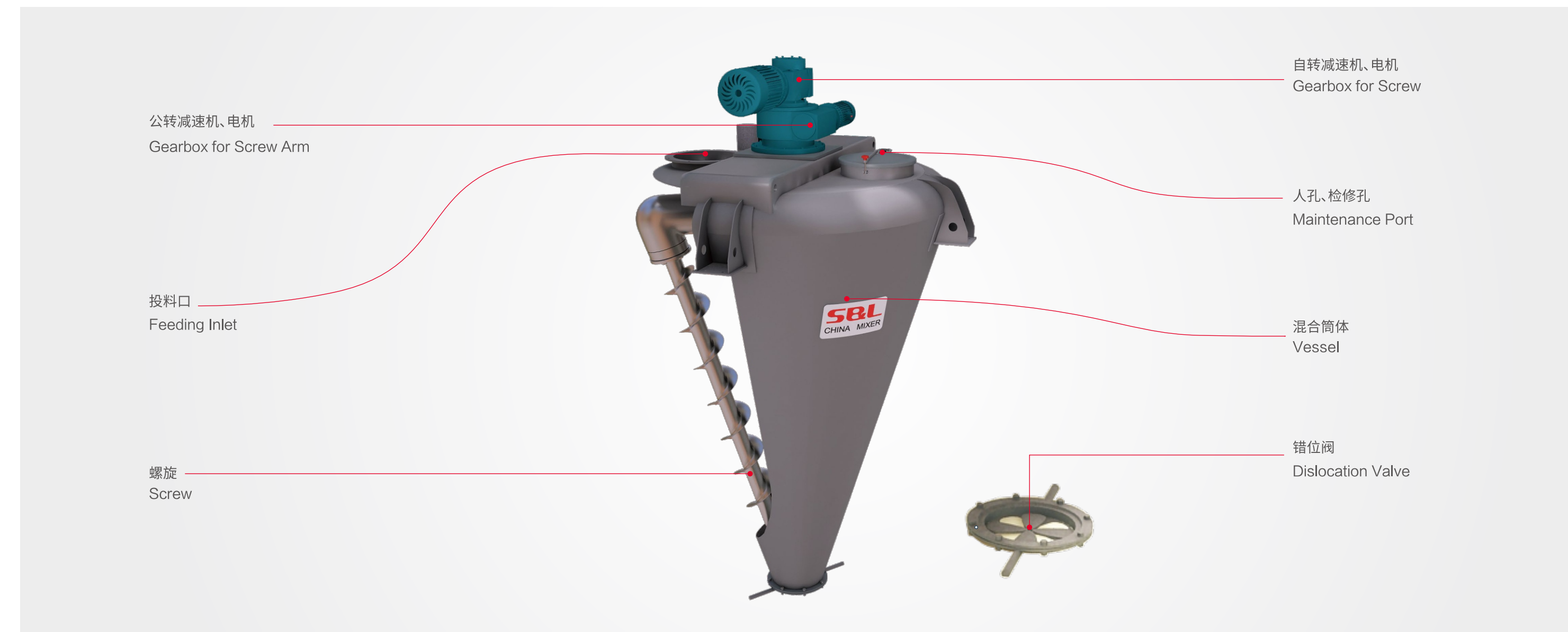
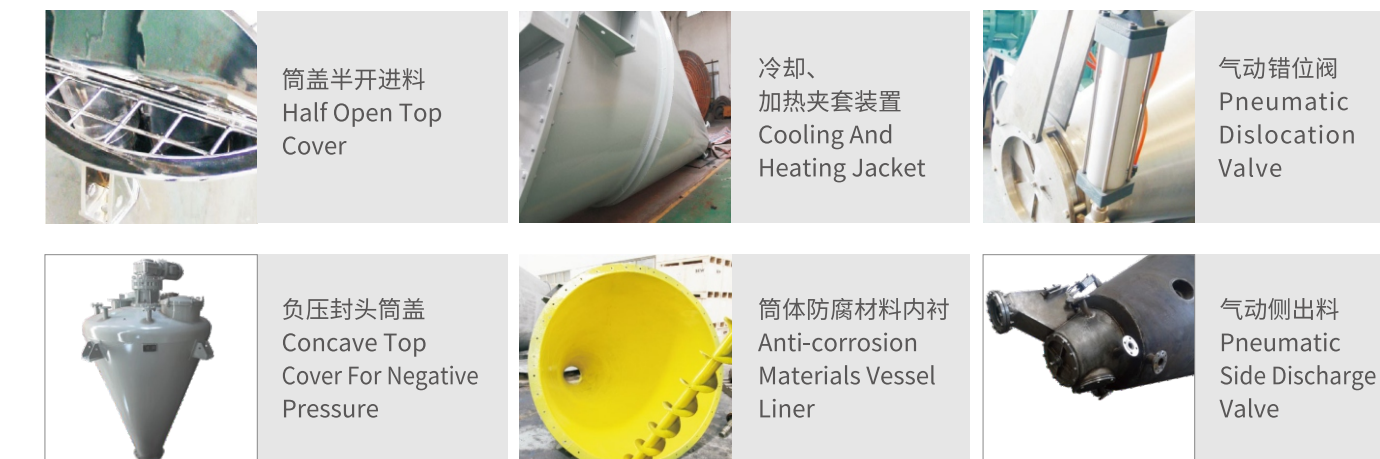

**高新技术企业 | 高端混合机领导者**  
NEW HIGH-TECH ENTERPRISE  
LEADING MANUFACTURER OF POWDER MIXING EQUIPMENT



# 精密制造

## PRECISED FABRICATION



双级双速摆线针轮减速机型  
Pin-Cycloid reducer



中间旋转喷液型  
Central spraying type



公、自转分开传动型  
Rotation and revolution drive



正(负)压型  
Negative(Positive)pressure



蜂窝夹套型  
Dimple Jacket



全夹套型  
Full Jacket

### 搅拌结构 | Stir Structure



单螺旋搅拌结构  
Single Screw Design



双螺旋搅拌结构  
Double Screws Design



三螺旋搅拌结构  
Triple Screws Design



中间旋转喷液型  
Central Rotary Spraying Design



设备可选配雾化喷头或喷淋头,使雾化的液体成扇形、空圆锥形均匀的喷向物料,以达到均匀充分混合,满足不同工艺的需求。

Atomizing nozzles or spraying nozzles are available on request. creating fan shape or hollow cone, Liquid flow into mixtures to reach intensive mixing.



### 应用范围 | Applications



染料 Dyestuff

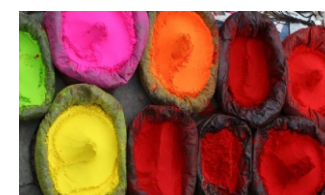

颜料 Pigment



电池 Battery



农药 Pesticide



生物制品 Bioproduct



医药 Pharmaceutical Product



食品 Food

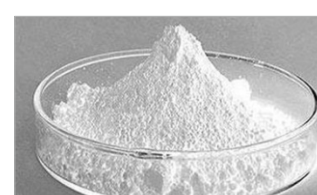

钛白粉 Titanium Powder



矿物稀土 Mineral Earth



磁材 Magnetic material



化工 Chemicals



高分子材料 Polymer Material

# 创新技术

## INNOVATED TECHNOLOGY

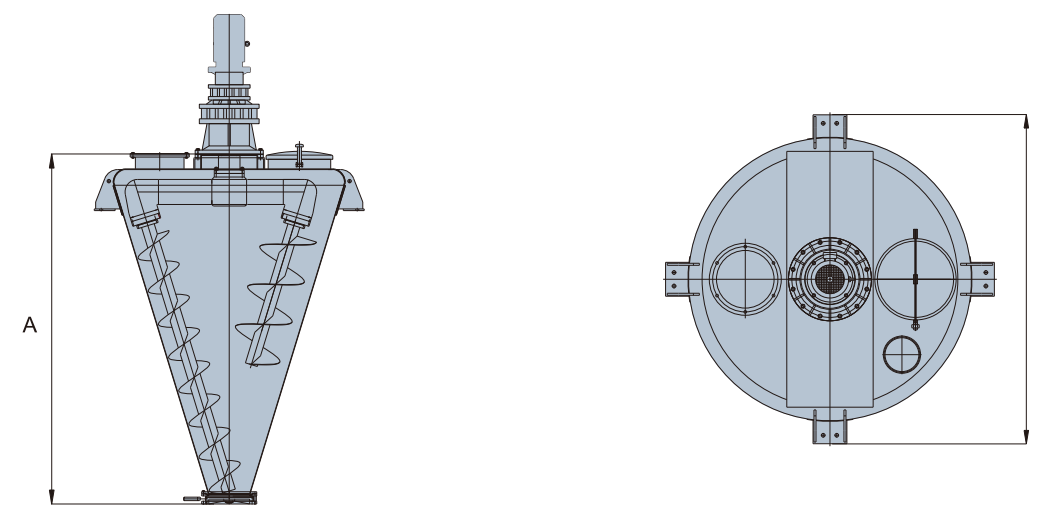

Model 型号	A	B	Motor Power 电机功率 (KW)	Working Volume 可用容量 (dm <sup>3</sup> )	Dry Weight 空载重量 (kg)
DSH-0.06	1451	630	1.5	0.03	150
DSH-0.1	1569	715	1.5	0.06	250
DSH-0.3	1300	1014	2.2	0.18	550
DSH-0.5	1600	1186	3	0.3	600
DSH-1	2000	1608	4	0.6	1200
DSH-1.5	2300	1760	5.5	0.9	1350
DSH-2	2600	1942	5.5	1.2	1500
DSH-3	2800	2170	7.5	1.8	2300
DSH-4	3200	2412	11	2.4	2520
DSH-6	3700	2703	15	3.6	3000
DSH-8	4100	2950	18.5	4.8	1500
DSH-10	4500	3188	22	6	5500
DSH-12	4700	3367	30	7.2	5900
DSH-15	5100	3605	30	9	6600
DSH-20	5500	3934	37	12	9800
DSH-25	6100	4215	30	15	10200
DSH-30	6400	4460	37	18	11500

1. 设备的装载量因物料特性和使用工艺不同而有所变化;
2. 物料比重大、有黏性、长时间沉积不可负载启动。

经中国合格评定国家认可委员会 (CNAS) 认证注册的实验室,发布于2009年3月28日  
Released by lab registered to China National Accreditation Service for Conformity Assessment (CNAS) on March 28, 2009



粉体混合  
Mixing of powders

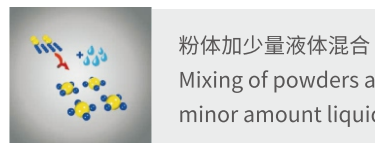

粉体加少量液体混合  
Mixing of powders and minor amount liquids

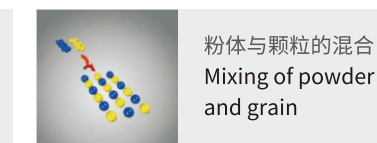

粉体与颗粒的混合  
Mixing of powder and grain

# 美好未来

## BRIGHT FUTURE

### 发展历程 | BRIGHT FUTURE

- 1989 满怀创新理念, 创立上海双龙混合机厂。
- 1991 引进美国技术, 开发出卧式螺带混合机。
- 1992 与韩国SIJI公司合作, 首家在中国生产无重力双轴桨叶混合机, 开创高精度粉体混合的先河。
- 1993 引进德国技术, 开发出犁刀式混合机。
- 1994 为欧美、韩国提供OEM产品。
- 1995 更名为上海双龙混合设备制造有限公司。
- 1996 开发出三螺旋锥形混合机, 专门用于明胶、钛白粉等行业。
- 2001 成立上海双龙防爆电机有限公司, 建立自主电机生产基地。
- 2007 更名为: 双龙集团有限公司。
- 2014 上海总部实现装备技术升级, 大型全自动智能装备投入生产, 全力打造高精、高端产品。
- 2018 进军锂电原料加工行业, 浙江生产基地投产。
- 2022 目前, 双龙集团在中国拥有3家子公司、3个生产基地。其用户遍及全球60多个国家, 极大的扩大了公司的知名度。凭借激情上进的员工队伍, 以及技术创新、品质卓越的产品, 双龙公司已整装待发、面向未来, 迎接挑战!